



BPW Special tools for BPW axles





BPW Special Tools

BPW tools offer the following advantages:



Tried and tested design

Tools must prove their worth in hard, everyday use.

Only then does it become clear whether tools are up to the demands of the real world.



Use of high quality materials

High quality materials are absolutely essential for producing high quality tools. Continuous quality assurance guarantees consistent quality.



Favourable price/performance ratio

Quality is not always obvious at first glance (e.g. materials).

Buying quality tools is often the cheaper option in the long term.

This particularly applies in those cases where tools are regularly needed and where their trouble free use must be guaranteed at all times.



Long service life, low wear

BPW tools are designed to be particularly resistant to wear and tear, and guarantee an extremely long service life, even with frequent use.



Simple to handle

Ideal solutions are always simple. This statement also particularly applies to tools. For that reason BPW tools are designed strictly to meet the technically necessary requirements. Solutions that do not meet practical requirements are rigorously weeded out at the development stage.

The following pages show a representative range of tools available.

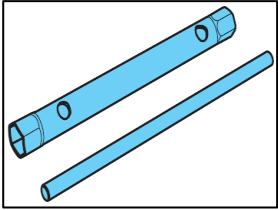

Box Spanner with Lever Pin

Combination box spanner for wheel nuts



SW Octagonal 30/ 32mm
03.364.99.03.0

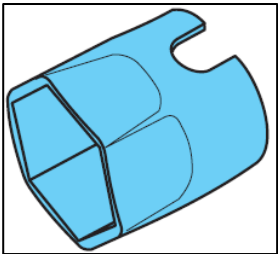
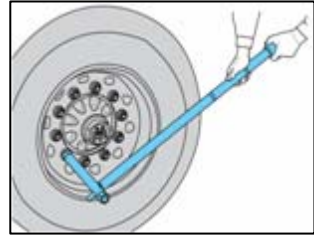

Box Spanner for Axle Nut

Box spanner for setting of BPW Hub Unit axle nuts.

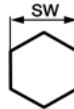

SW Hexagonal
65 mm - **03.364.20.01.0**
80 mm - **03.364.24.01.0**

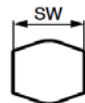
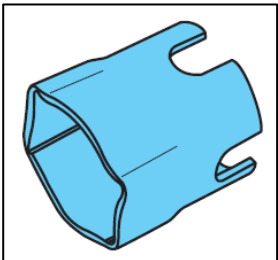
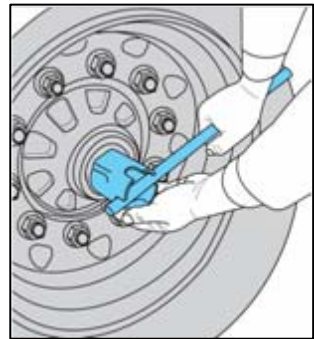

SW BPW Shape
65 mm - **03.364.20.02.0**
80 mm - **03.364.24.02.0**

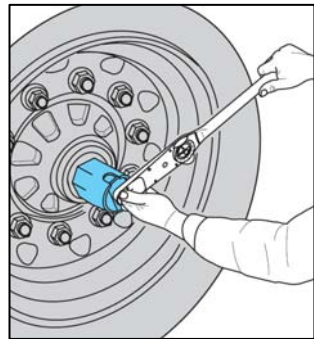

Steel tube, galvanised



Always check the setting with a torque wrench as soon as possible afterwards



Ring Spanner with Hub Cap

Designed for emergency use, this ring spanner can be carried in the vehicle tool kit for use anywhere at any time.

Caution – repeated use of this spanner may lead to damage to the hub caps.

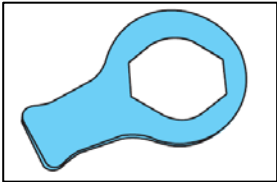
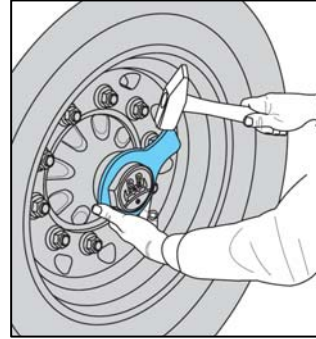

- SW Octagonal
- 95 mm - **03.339.04.01.0**
 - 110 mm - **03.339.05.01.0**
 - 120 mm - **03.339.05.02.0**
 - 130 mm - **03.339.05.03.0**

- SW BPW Shape
- 95 mm - **03.339.04.03.0**
 - 110 mm - **03.339.05.04.0**

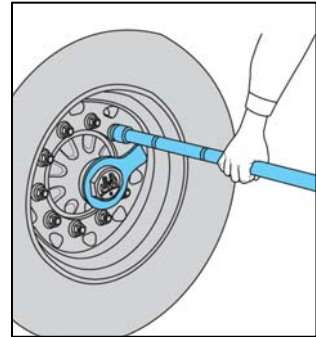

Always check the setting with a torque wrench as soon as possible afterwards



Ring Spanner for Axle Nut ECOPlus

- SW Octagonal
- 95 mm - **03.339.05.05.0**

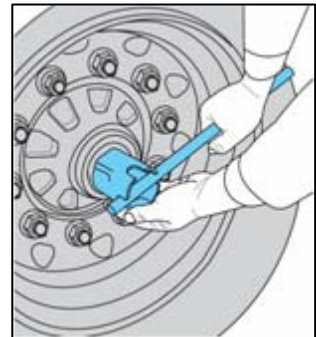

ECOPlus axle nuts do not require a torque wrench. The axle nut has an integrated torque limiter. Do not use an impact driver

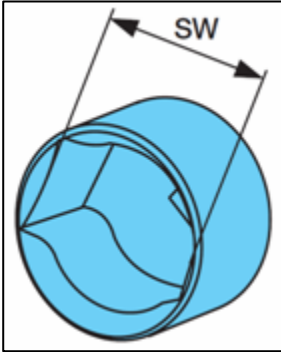

Chromium steel box spanner (31 CR V 3)

Box Spanner for Workshop Use

To correctly set the bearing play in the hub utilising a torque wrench.

For Axle Nuts -

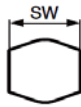

SW BPW Shape
65 mm - **03.364.20.03.0**
80 mm - **03.364.24.03.0**

For Hub Caps -



SW BPW Shape
95 mm - **03.364.29.02.0**
110 mm - **03.364.29.03.0**

All BPW box spanners require either a ½" or a 1" drive torque wrench

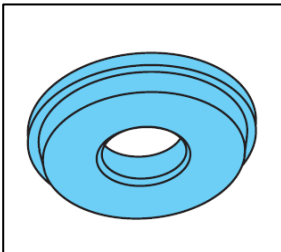
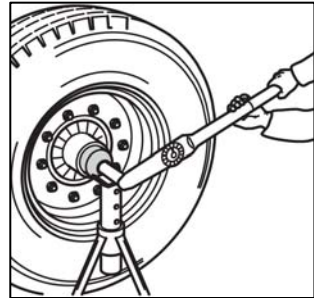
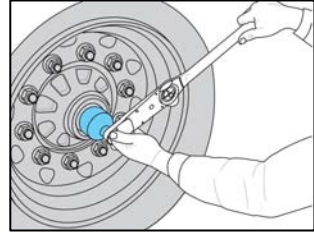

Roller Bearing Press Tools

Press tools, for inserting the outer rings of the roller bearings

- 15.011.20052 Ø 142 33118
- 15.013.20052 Ø 113 33213
- 15.012.20052 Ø 123 33116
- 15.005.20052 Ø 100 32310





Driving Mandrel for S-Cam Bushes

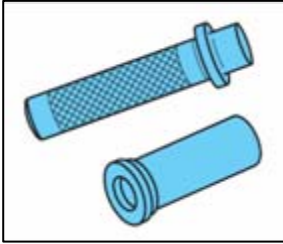

Handle and mandrel available to correctly seat replacement s-cam bushes on BPW drum brake axles.

Mandrel Ø 42 03.084.17.01.0
Handle 02.0619.02.00

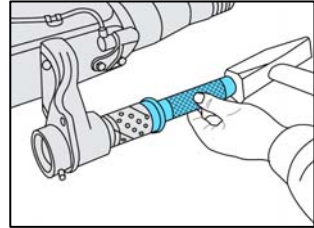

Pulling Device for Slack Adjusters

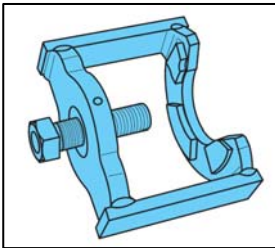

To quickly and safely remove slack adjusters on BPW drum brakes. Suitable for both manual and automatic slack adjusters

02.4306.15.00

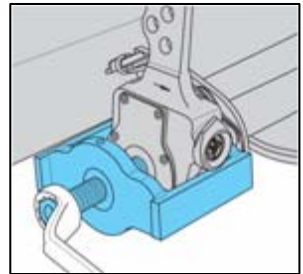

Exciter Ring Assembly Aid

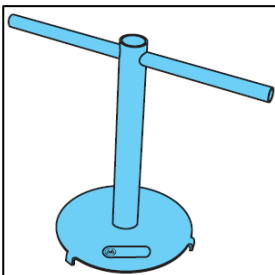

To fit and remove ABS exciter ring from BPW 9 tonne ECO Plus Hub Unit axles. Suitable for both disc and drum brake axles.

16.020.22953

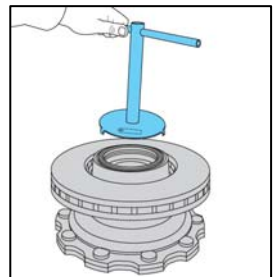



Grease Shower

To quickly, accurately and cleanly fill the bearing with the required amount of BPW special long life grease **ECO-LiPlus**

Available to suit:-

33116 / 32310 bearings - **99.00.000.9.54**

33118 / 33213 bearings - **99.00.000.9.55**

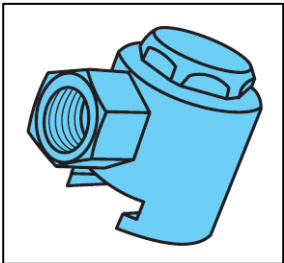
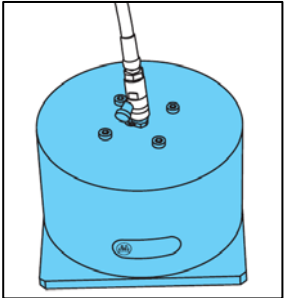
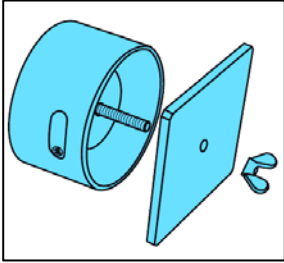

A flat grease nipple adapter is included in the complete set.

